

USB-1208FS

Analog and Digital I/O

User's Guide

Your new Measurement Computing product comes with a fantastic extra —

Management committed to your satisfaction!

Thank you for choosing a Measurement Computing product—and congratulations! You own the finest, and you can now enjoy the protection of the most comprehensive warranties and unmatched phone tech support. It's the embodiment of our mission:

To provide data acquisition hardware and software that will save time and save money.

Simple installations minimize the time between setting up your system and actually making measurements. We offer quick and simple access to outstanding live FREE technical support to help integrate MCC products into a DAQ system.

Limited Lifetime Warranty: Most MCC products are covered by a limited lifetime warranty against defects in materials or workmanship for the life of the product, to the original purchaser, unless otherwise noted. Any products found to be defective in material or workmanship will be repaired, replaced with same or similar device, or refunded at MCC's discretion. For specific information, please refer to the terms and conditions of sale.

Harsh Environment Program: Any Measurement Computing product that is damaged due to misuse, or any reason, may be eligible for replacement with the same or similar device for 50% of the current list price. I/O boards face some harsh environments, some harsher than the boards are designed to withstand. Contact MCC to determine your product's eligibility for this program.

30 Day Money-Back Guarantee: Any Measurement Computing Corporation product may be returned within 30 days of purchase for a full refund of the price paid for the product being returned. If you are not satisfied, or chose the wrong product by mistake, you do not have to keep it.

These warranties are in lieu of all other warranties, expressed or implied, including any implied warranty of merchantability or fitness for a particular application. The remedies provided herein are the buyer's sole and exclusive remedies. Neither Measurement Computing Corporation, nor its employees shall be liable for any direct or indirect, special, incidental or consequential damage arising from the use of its products, even if Measurement Computing Corporation has been notified in advance of the possibility of such damages.

Trademark and Copyright Information

Measurement Computing Corporation, InstaCal, Universal Library, and the Measurement Computing logo are either trademarks or registered trademarks of Measurement Computing Corporation. Refer to the Copyrights & Trademarks section on mccdaq.com/legal for more information about Measurement Computing trademarks. Other product and company names mentioned herein are trademarks or trade names of their respective companies.

© 2012 Measurement Computing Corporation. All rights reserved. No part of this publication may be reproduced, stored in a retrieval system, or transmitted, in any form by any means, electronic, mechanical, by photocopying, recording, or otherwise without the prior written permission of Measurement Computing Corporation.

Notice

Measurement Computing Corporation does not authorize any Measurement Computing Corporation product for use in life support systems and/or devices without prior written consent from Measurement Computing Corporation. Life support devices/systems are devices or systems that, a) are intended for surgical implantation into the body, or b) support or sustain life and whose failure to perform can be reasonably expected to result in injury. Measurement Computing Corporation products are not designed with the components required, and are not subject to the testing required to ensure a level of reliability suitable for the treatment and diagnosis of people.

Table of Contents

Preface

About this User's Guide	5
What you will learn from this user's guide	5
Conventions in this user's guide	5
Where to find more information	5

Chapter 1

Introducing the USB-1208FS.....	6
USB-1208FS block diagram.....	6
Connecting a USB-1208FS to your computer is easy	7

Chapter 2

Installing the USB-1208FS.....	8
What comes with your shipment?.....	8
Hardware	8
Software.....	8
Documentation.....	8
Unpacking.....	8
Installing the software	8
Installing the hardware	8

Chapter 3

Functional Details	9
Analog input acquisition modes	9
Software paced mode.....	9
Hardware paced mode.....	9
External components	9
USB connector.....	9
LED	9
Screw terminals.....	10
Signal connections	11
Analog input	11
Analog output	14
Digital I/O.....	14
Counter input	15
Trigger input	15
SYNC I/O	15
Calibration output	15
Ground.....	15
Power output.....	16
Accuracy.....	16
Synchronized operations.....	18
Mechanical drawings	19

Chapter 4

Specifications	20
Analog input	20
Analog output	22
Digital I/O.....	22
External trigger	23
External clock input/output.....	23
Counter	24
Non-volatile memory.....	24

Microcontroller	24
Power	25
General	25
Environmental	25
Mechanical	25
Screw terminal connector	26
Differential mode pinout.....	26
Single-ended mode pinout	27
Declaration of Conformity	28

About this User's Guide

What you will learn from this user's guide

This user's guide describes the Measurement Computing USB-1208FS data acquisition device and lists device specifications.

Conventions in this user's guide

For more information

Text presented in a box signifies additional information and helpful hints related to the subject matter you are reading.

Caution! Shaded caution statements present information to help you avoid injuring yourself and others, damaging your hardware, or losing your data.

bold text **Bold** text is used for the names of objects on a screen, such as buttons, text boxes, and check boxes.

italic text *Italic* text is used for the names of manuals and help topic titles, and to emphasize a word or phrase.

Where to find more information

Additional information about the USB-1208FS is available on our website at www.mccdaq.com. You can also contact Measurement Computing Corporation by phone, fax, or email with specific questions.

- Phone: 508-946-5100 and follow the instructions for reaching Tech Support
- Fax: 508-946-9500 to the attention of Tech Support
- Email: techsupport@mccdaq.com

Introducing the USB-1208FS

The USB-1208FS is a USB 2.0 full-speed analog input and digital I/O data acquisition device supported under popular Microsoft® Windows® operating systems. It is designed for USB 1.1 ports, and was tested for full compatibility with both USB 1.1 and USB 2.0 ports.

The USB-1208FS features eight analog inputs, two 12-bit analog outputs, 16 digital I/O connections, and one 32-bit external event counter.

The analog inputs are software configurable for either eight 11-bit single-ended inputs, or four 12-bit differential inputs. Sixteen digital I/O lines are independently selectable as input or output in two 8-bit ports. A 32-bit counter can count TTL pulses. The counter increments when the TTL levels transition from low to high (rising-edge). A SYNC (synchronization) input / output line lets you pace the analog input acquisition of one USB module from the clock output of another.

The USB-1208FS is powered by the +5 volt USB supply from your computer. No external power is required. All I/O connections are made to the device screw terminals.

USB-1208FS block diagram

USB-1208FS functions are illustrated in the block diagram shown here.

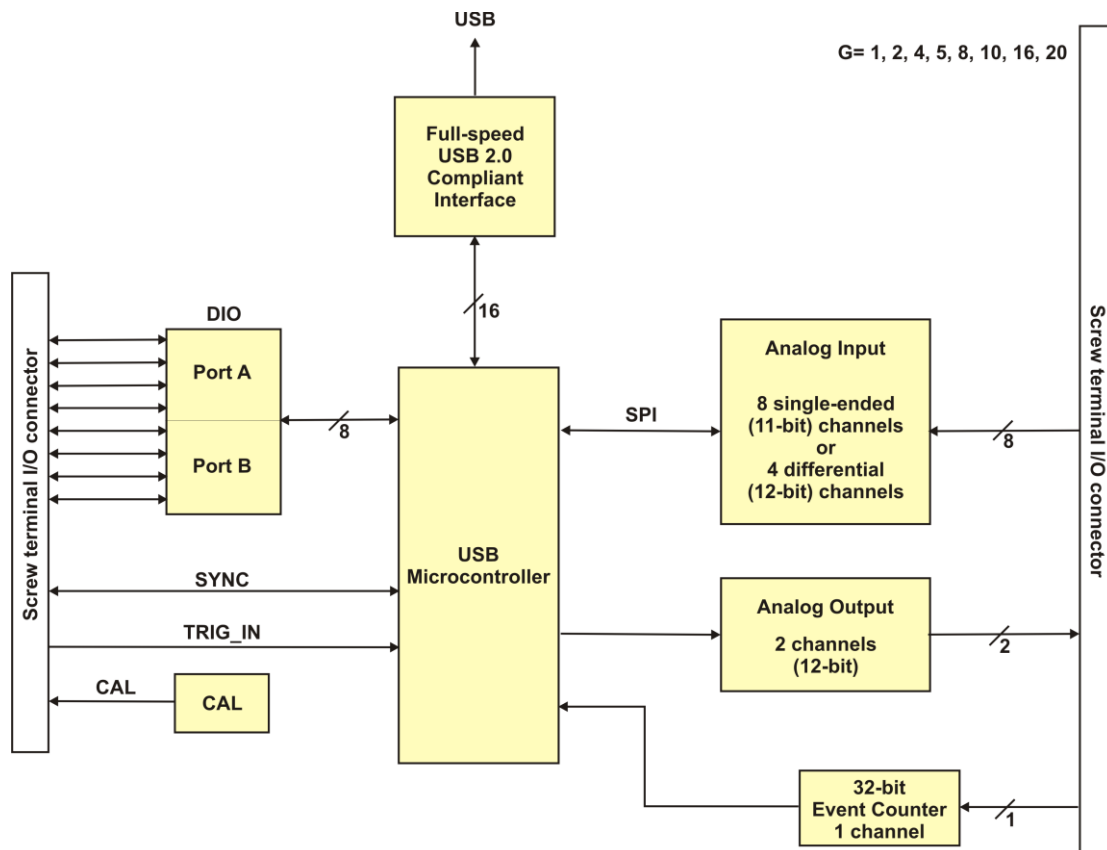

Figure 1. USB-1208FS functional block diagram

Connecting a USB-1208FS to your computer is easy

Installing a data acquisition device has never been easier.

- The USB-1208FS relies upon the Microsoft Human Interface Device (HID) class drivers. The HID class drivers ship with every copy of Windows that is designed to work with USB ports. We use the Microsoft HID because it is a standard, and its performance delivers full control and maximizes data transfer rates for your USB-1208FS. No third-party device driver is required.
- The USB-1208FS is plug-and-play. There are no jumpers to position, DIP switches to set, or interrupts to configure.
- You can connect the USB-1208FS before or after you install the software, and without powering down your computer first. When you connect an HID to your system, your computer automatically detects it and configures the necessary software. You can connect and power multiple HID peripherals to your system using a USB hub.

You can run up to two USB-1208FS devices on most computers.

- You can connect your system to various devices using a standard four-wire cable. The USB connector replaces the serial and parallel port connectors with one standardized plug and port combination.
- You do not need a separate power supply module. The USB automatically delivers the electrical power required by each peripheral connected to your system.
- Data flow is bidirectional between a computer and peripheral over USB connections.

Installing the USB-1208FS

What comes with your shipment?

The following items are shipped with the USB-1208FS.

Hardware

- USB-1208FS
- USB cable

Software

- MCC DAQ CD

Documentation

In addition to this hardware user's guide, you should also receive the *Quick Start Guide*. This booklet provides an overview of the MCC DAQ software you received with the device, and includes information about installing the software. Please read this booklet completely before installing any software or hardware.

Unpacking

As with any electronic device, take care while handling to avoid damage from static electricity. Before removing the USB-1208FS from its packaging, ground yourself using a wrist strap or touch either the computer chassis or other grounded object to eliminate any stored static charge. If the device is damaged, notify Measurement Computing Corporation immediately by phone, fax, or email.

- Phone: 508-946-5100 and follow the instructions for reaching Tech Support
- Fax: 508-946-9500 to the attention of Tech Support
- Email: techsupport@mccdaq.com

For international customers, contact your local distributor. Refer to the International Distributors section on our web site at www.mccdaq.com/International.

Installing the software

Refer to the *Quick Start Guide* for instructions on installing the software on the MCC DAQ CD. This booklet is available in PDF at www.mccdaq.com/PDFmanuals/DAQ-Software-Quick-Start.pdf.

Installing the hardware

Be sure you are using the latest system software

Before installing the device, run Windows Update to update your operating system with the latest HID and USB drivers.

To connect the USB-1208FS to your system, connect the USB cable to a USB port on your computer or to an external USB hub that is connected to your computer.

The USB-1208FS installs as a composite device with separate devices attached. When you connect the USB-1208FS for the first time, a **Found New Hardware** dialog opens as each device interface is detected. This is normal. After the device is installed its LED will blink and then remain on. This indicates that communication is established between the USB-1208FS and your computer.

If the LED turns off

If communication is lost between the device and the computer, the device LED turns off. Disconnect the USB cable from the computer and then reconnect it. This should restore communication, and the LED should turn on.

Functional Details

Analog input acquisition modes

The USB-1208FS can acquire analog input data in two different modes – software paced and hardware paced.

Software paced mode

In software paced mode you can acquire one analog sample at a time. You initiate the A/D conversion by calling a software command. The analog value is converted to digital and returned to the computer. You repeat this procedure until you have the total number of samples that you want from one channel.

The maximum throughput sample rate in software paced mode is system-dependent.

Hardware paced mode

In hardware paced mode you can acquire data from up to eight channels. The analog data is continuously acquired and converted to digital values until you stop the scan. Data is transferred in blocks of 31 samples from the USB-1208FS to the memory buffer on your computer.

The maximum continuous scan rate of 50 kS/s is an aggregate rate. The total acquisition rate for all channels cannot exceed 50 kS/s. You can acquire data from one channel at 50 kS/s, two channels at 25 kS/s, and four channels at 12.5 kS/s. You can start a continuous scan with either a software command or with an external hardware trigger event.

External components

The USB-1208FS has the following external components, as shown in Figure 2.

- USB connector
- LED
- Screw terminal banks

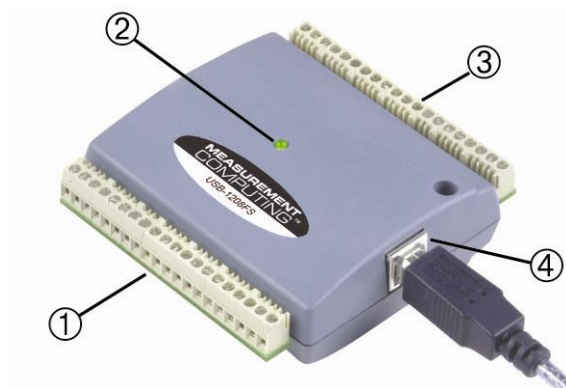

- | | | | |
|---|------------------------------|---|-----------------------------|
| 1 | Screw terminal pins 21 to 40 | 3 | Screw terminal pins 1 to 20 |
| 2 | LED | 4 | USB connector |

Figure 2. External components

USB connector

The USB connector provides +5V power and communication. No external power supply is required.

LED

The LED indicates the communication status; it cannot be disabled. LED states are listed in the table below.

LED behavior

LED Illumination	Indication
Steady green	The USB-1208FS is connected to a computer or external USB hub.
Blinks continuously	Data is being transferred.

Screw terminals

The screw terminals provide the following connections:

- Eight analog inputs (**CH0 IN** to **CH7 IN**)
- Two analog outputs (**D/A OUT 0** to **D/A OUT 1**)
- 16 digital I/O connections (**PortA0** to **Port A7**, and **Port B0** to **Port B7**)
- One external trigger input (**TRIG_IN**)
- One external event counter input (**CTR**)
- One SYNC I/O for external clocking and multi-unit synchronization (**SYNC**)
- One calibration output (**CAL**)
- One power output (**PC +5 V**)
- Five analog ground connections (**AGND**) and four digital ground connections (**GND**)
- One ground connection (**GND**)

Use 16 AWG to 30 AWG wire when making connections to the screw terminals. The single-ended mode pinout is shown in Figure 3.

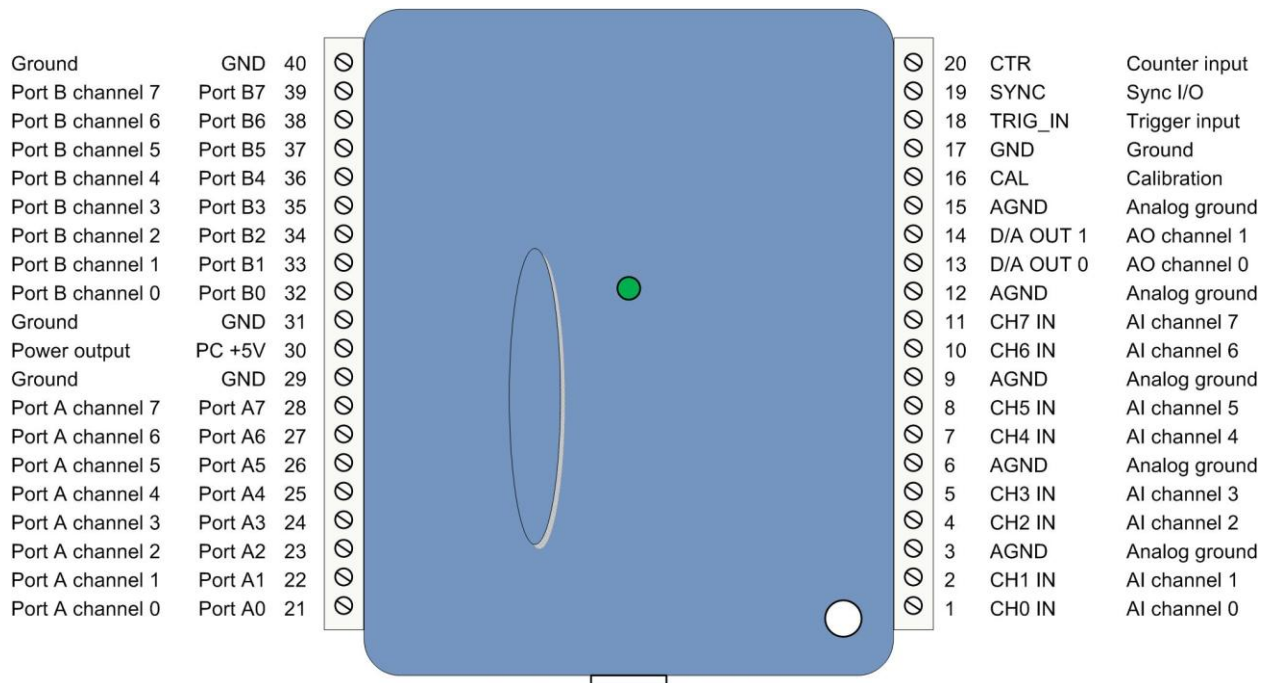

Figure 3. Single-ended mode pinout

The differential mode pinout is shown in Figure 4.

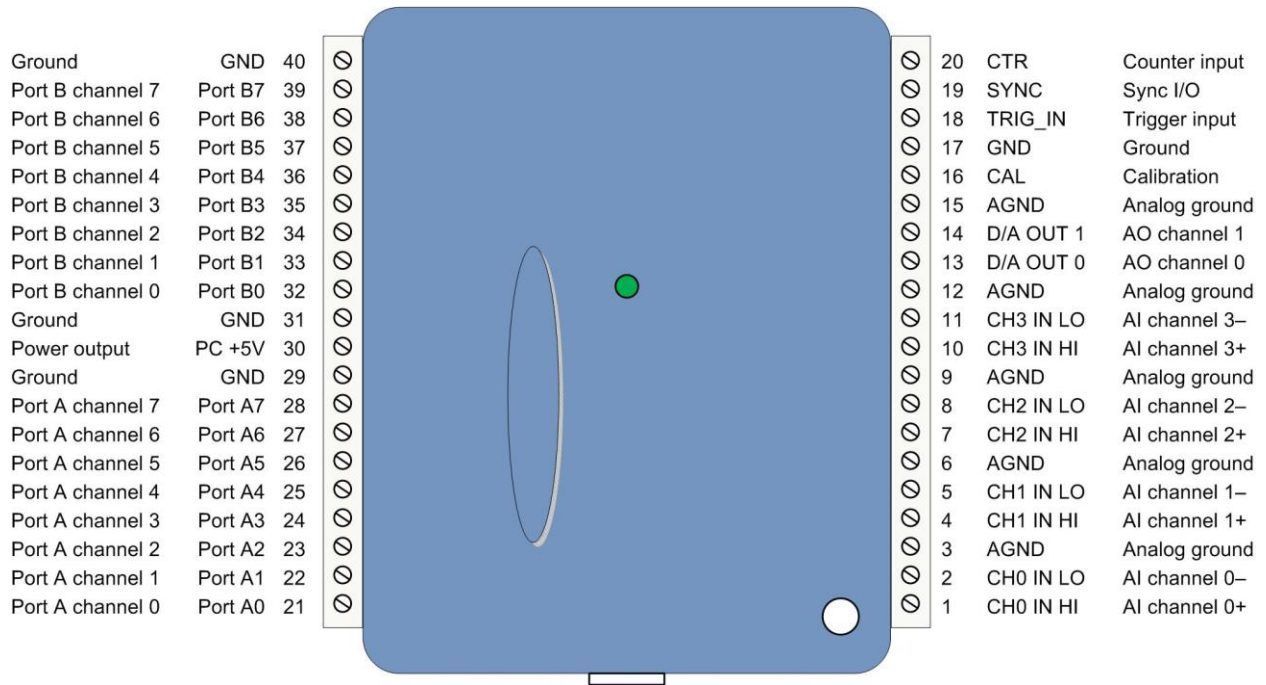

Figure 4. Differential mode pinout

Signal connections

Analog input

You can connect up to eight single-ended analog input connections to **CH0 IN** through **CH7 IN**, or four differential connections to **CH0 IN HI/LO** through **CH3 IN HI/LO**.

You can configure the analog input channels as eight single-ended channels or four differential channels. When configured for differential mode, each analog input has 12-bit resolution. When configured for single-ended mode, each analog input has 11-bit resolution, due to restrictions imposed by the A/D converter.

Single-ended configuration

When configured for single-ended input mode, eight analog channels are available. The input signal is referenced to signal ground (GND), and delivered through two wires:

- Connect the wire carrying the signal to be measured to **CH# IN**.
- Connect the second wire to **AGND**.

The input range for single-ended mode is ± 10 V.

Single-ended measurements using differential channels

To perform a single-ended measurement using differential channels, connect the signal to the "**CH# IN HI**" input, and ground the associated "**CH# IN LO**" input.

Differential configuration

When the analog input channels are configured for differential input mode, four analog channels are available. In differential mode, the input signal is measured with respect to the low input.

The input signal is delivered through three wires:

- Connect the wire carrying the signal to be measured to **CH# IN HI**.
- Connect the wire carrying the reference signal to **CH# IN LO**.
- Connect the third wire to **GND**.

A low-noise precision programmable gain amplifier (PGA) is available on differential channels to provide gains of up to 20 and a dynamic range of up to 12-bits. Differential mode input voltage ranges are $\pm 20\text{ V}$, $\pm 10\text{ V}$, $\pm 5\text{ V}$, $\pm 4\text{ V}$, $\pm 2.5\text{ V}$, $\pm 2.0\text{ V}$, $\pm 1.25\text{ V}$, and $\pm 1.0\text{ V}$.

In differential mode, the following two requirements must be met for linear operation:

- Any analog input must remain in the -10 V to $+20\text{ V}$ range with respect to ground at all times.
- The maximum differential voltage on any analog input pair must remain within the selected voltage range.

The input [*common-mode voltage + signal*] of the differential channel must be in the -10 V to $+20\text{ V}$ range in order to yield a useful result. For example, you input a 4 V pp sine wave to CHHI, and apply the same sine wave 180° out of phase to CHLO. The common mode voltage is 0 V . The differential input voltage swings from $4\text{ V} - (-4\text{ V}) = 8\text{ V}$ to $-4\text{ V} - 4\text{ V} = -8\text{ V}$. Both inputs satisfy the -10 V to $+20\text{ V}$ input range requirement, and the differential voltage is suited for the $\pm 10\text{ V}$ input range (see Figure 5).

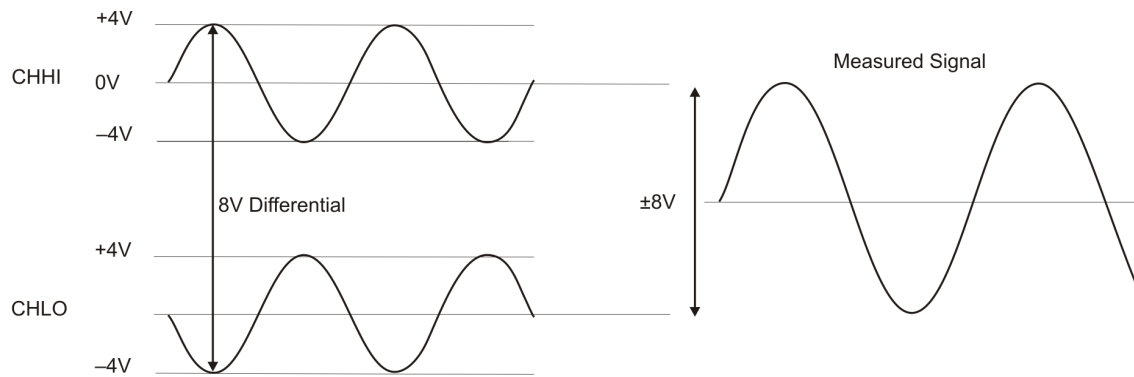

Figure 5. Differential voltage example: common mode voltage of 0 V

If you increase the common mode voltage to 11 V , the differential remains at $\pm 8\text{ V}$. Although the [*common-mode voltage + signal*] on each input now has a range of $+7\text{ V}$ to $+15\text{ V}$, both inputs still satisfy the -10 V to $+20\text{ V}$ input requirement (see Figure 6).

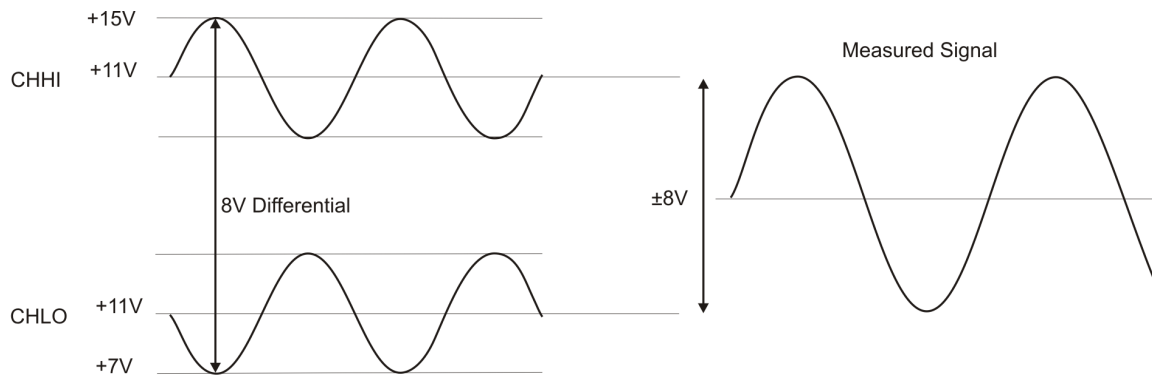

Figure 6. Differential voltage example: common mode voltage of 11 V

If you decrease the common-mode voltage to -7 V , the differential stays at $\pm 8\text{ V}$. However, the solution now violates the input range condition of -10 V to $+20\text{ V}$. The voltage on each analog input now swings from -3 V to -11 V . Voltages between -10 V and -3 V are resolved, but those below -10 V are clipped (see Figure 7).

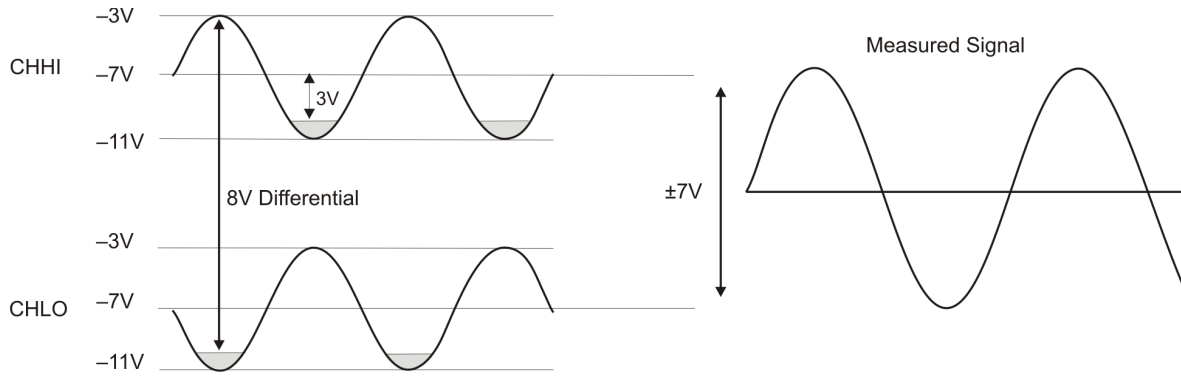

Figure 7. Differential voltage example: common mode voltage of -7 V

Since the analog inputs are restricted to a -10 V to $+20\text{ V}$ signal swing with respect to ground, all ranges *except* $\pm 20\text{ V}$ can realize a linear output for any differential signal with zero common mode voltage and full scale signal inputs. The $\pm 20\text{ V}$ range is the exception. You cannot put -20 V on CHHI and 0 V on CHLO since this violates the input range criteria.

The table below shows some possible inputs and the expected results.

Sample inputs and differential results

CHHI	CHLO	Result
-20 V	0 V	Invalid
-15 V	$+5\text{ V}$	Invalid
-10 V	0 V	-10 V
-10 V	$+10\text{ V}$	-20 V
0 V	$+10\text{ V}$	-10 V
0 V	$+20\text{ V}$	-20 V
$+10\text{ V}$	-10 V	$+20\text{ V}$
$+10\text{ V}$	0 V	$+10\text{ V}$
$+15\text{ V}$	-5 V	$+20\text{ V}$
$+20\text{ V}$	0	$+20\text{ V}$

For more information on analog signal connections

For more information on single-ended and differential inputs, refer to the *Guide to Signal Connections* (this document is available on our web site at www.mccdaq.com/signals/signals.pdf)

Channel-Gain queue

The channel gain queue feature allows you to set up a scan sequence with a unique per-channel gain setting and channel sequence. The gain settings are stored in a channel-gain queue list that is written to local memory on the device.

The channel-gain queue list can contain up to 16 elements in any order. The channel-gain queue list can contain up to 16 elements in any order. An example of a four-element list is shown in the table below..

Sample channel-gain queue list

Element	Channel	Range
0	CH0	BIP10V
1	CH0	BIP5V
2	CH7	BIP10V
3	CH2	BIP1V

When a scan begins with the gain queue enabled, the USB-1208FS reads the first element, sets the appropriate channel number and range, and then acquires a sample. The properties of the next element are then retrieved, and another sample is acquired. This sequence continues until all elements in the gain queue have been selected.

When the end of the channel list is detected, the sequence returns to the first element in the list. This sequence repeats until the specified number of samples is acquired.

Carefully match the gain to the expected voltage range on the associated channel or an over range condition may occur. Although this condition does not damage the device, it does produce a useless full-scale reading, and can introduce a long recovery time due to saturation of the input channel.

Analog output

You can connect up to two analog output connections to **D/A OUT 0** and **D/A OUT 1**. Each channel can be paced individually at rates up to 10,000 updates per second. Both channels can be paced simultaneously using the same time base at 5,000 updates per channel. The 0 V to 4.096 V output range provides a convenient 1 mV per LSB when setting the output voltage levels.

Digital I/O

The device has 16 digital bits that are configured as two 8-bit ports (Port A and Port B). You can connect up to eight digital I/O lines to each port (terminals **Port A0** to **Port A7** and **Port B0** to **Port B7**). Each port is configurable as either input or output.

When configured for input, you can use the digital I/O terminals to detect the state of any TTL level input. Refer to the schematic shown in Figure 8.

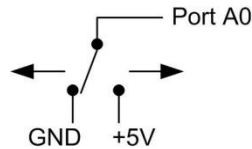

Figure 8. Schematic showing switch detection by digital channel Port A0

If you set the switch to the +5V input, DIO0 reads *TRUE* (1). When set to GND, Port A0 reads *FALSE* (0).

For more information on digital signal connections

For more information on digital signal connections and digital I/O techniques, refer to the *Guide to Signal Connections* (available on our web site at www.mccdaq.com/signals/signals.pdf).

Pull-up/down configuration

Boards designed with hardware revision D and later have user-configurable internal jumpers to configure the digital bits for pull-up (default) or pull-down. The hardware revision is listed with the part number on the bottom of the device, for example P/N 193331D.

If the p/n of your board is earlier than hardware revision D, the default configuration is pull-up. To configure for pull-down, the board must be modified at the factory.

If your board has user-configurable jumpers, complete the following steps to set the pull-up/down configuration:

1. Unplug the device from the computer.
2. Turn the device over and rest the top of the housing on a flat, stable surface.

Caution! The discharge of static electricity can damage some electronic components. Before removing the USB-1208FS from its housing, ground yourself using a wrist strap or touch the computer chassis or other grounded object to eliminate any stored static charge.

3. Remove the three screws from the bottom of the device using a #1 Philips head screwdriver.
4. Hold both the top and bottom sections together, turn the device over and rest it on the surface, then carefully remove the top section of the case to expose the circuit board.

The user-configurable jumpers are labeled **DIO A** and **DIO B**. Figure 9 shows the location of the each jumper on the circuit board.

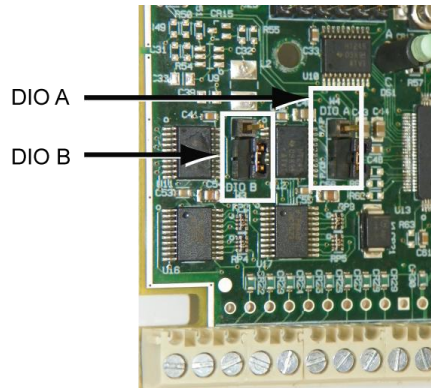

Figure 9. Pull-up/down jumper locations

- Configure each jumper for pull-up or pull-down, as shown in Figure 10. Use the jumper labeled **DIO A** to configure Port A, and **DIO B** to configure Port B.

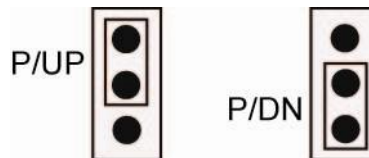

Figure 10. Pull-up/down jumper configuration

- Replace the top section of the housing, and fasten it to the bottom section with the three screws.

Counter input

The **CTR** terminal is a 32-bit event counter that can accept frequency inputs up to 1 MHz. The internal counter increments when the TTL levels transition from low to high.

Trigger input

The **TRIG_IN** terminal is an external digital trigger input that you can configure for either rising or falling edge.

SYNC I/O

The **SYNC** terminal is a bidirectional I/O signal that can be configured as an input (default) or an output.

- Configure as an external clock input to externally source the A/D conversions. The SYNC terminal supports TTL-level input signals of up to 50 kHz.
- Configure as an output to pace conversions on a second USB-1208FS device and acquire data from 16 channels. For more information synchronized operations see page 18.

Calibration output

The **CAL** terminal is an output used only to calibrate the device. Calibration is software-controlled via InstaCal.

Ground

The analog ground (**AGND**) terminals provide a common ground for all analog channels. The ground (**GND**) connections provide a common ground for the digital, trigger, counter, sync and power terminals.

Power output

The **PC +5V** terminal is a 5 volt output that is supplied by the computer. You can use this terminal to supply power to external devices or circuitry.

Caution! The **PC +5V** terminal is an output. Do not connect to an external power supply or you may damage the USB-1208FS and possibly the computer.

The maximum total output current that can be drawn from all USB-1208FS connections (power, analog and digital outputs) is 420 mA. This maximum applies to most personal computers and self-powered USB hubs. Bus powered hubs and notebook computers may limit the maximum available output current to 100 mA.

Just connecting the USB-1208FS to your computer draws 80 mA of current from the USB +5 V supply. Once you start running applications with the USB-1208FS, each DIO bit can draw up to 2.5 mA, and each analog output can draw 15 mA. The maximum amount of +5 V current available for experimental use, over and above that required by the USB-1208FS, is the difference between the *total current requirement* of the USB (based on the application), and the *allowed current draw* of the PC platform (500 mA for desktop PCs and self-powered hubs, or 100 mA for bus powered hubs and notebook computers).

With all outputs at their maximum output current, you can calculate the total current requirement of the USB-1208FS USB +5 V as follows:

$$(USB-1208FS @ 80 mA) + (16 DIO @ 2.5 mA ea) + (2 AO @ 15 mA ea) = 150 mA$$

For an application running on a PC or powered hub, the maximum available excess current is 500 mA–150 mA = 350 mA. This number is the total maximum available current at the PC +5 V screw terminals. Measurement Computing highly recommends that you figure in a safety factor of 20% below this maximum current loading for your applications. A conservative, safe user maximum in this case would be in the 350-380 mA range.

Since laptop computers typically allow up to 100 mA, the USB-1208FS in a fully-loaded configuration may be above that allowed by the computer. In this case, you must determine the per-pin loading in the application to ensure that the maximum loading criteria is met. The per-pin loading is calculated by simply dividing the +5 V by the load impedance of the pin in question.

Accuracy

The overall accuracy of any instrument is limited by the error components within the system. Resolution is often used incorrectly to quantify the performance of a measurement product. While "12-bits" or "1 part in 4,096" does indicate what can be resolved, it provides little insight into the quality of an absolute measurement. Accuracy specifications describe the actual measurement achievable with a USB-1208FS.

There are three types of errors which affect the accuracy of a measurement system:

- offset
- gain
- nonlinearity

The primary error sources in the USB-1208FS are offset and gain. Nonlinearity is small in the USB-1208FS, and is not significant as an error source with respect to offset and gain.

Figure 11 shows an ideal, error-free, USB-1208FS transfer function. The typical calibrated accuracy of the USB-1208FS is range-dependent, as explained in the [Specifications](#) chapter on page 20. We use a ± 10 V range here as an example of what you can expect when performing a measurement in this range.

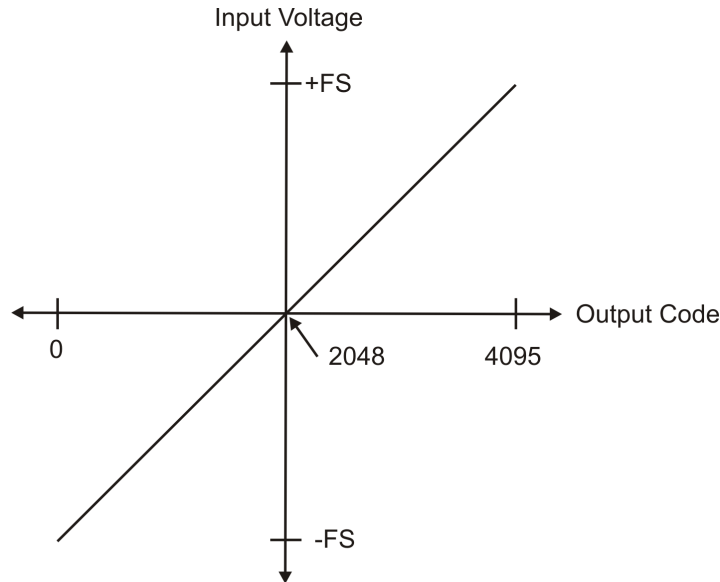

Figure 11. Ideal ADC transfer function

The USB-1208FS offset error is measured at mid-scale. Ideally, a zero volt input should produce an output code of 2048. Any deviation from this is an offset error. Figure 12 shows the USB-1208FS transfer function with an offset error. The typical offset error specification on the ± 10 V range is ± 9.77 mV. Offset error affects all codes equally by shifting the entire transfer function up or down along the input voltage axis.

The accuracy plots in Figure 12 are drawn for clarity and are not drawn to scale.

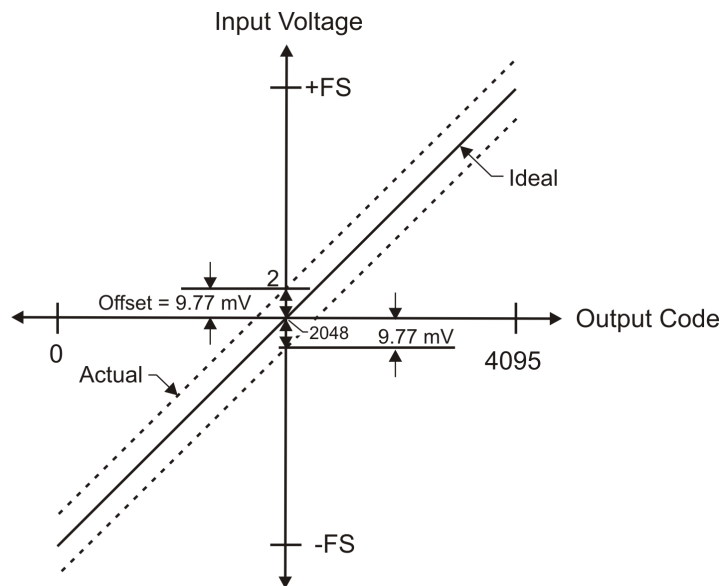

Figure 12. ADC transfer function with offset error

Gain error is a change in the slope of the transfer function from the ideal, and is typically expressed as a percentage of full-scale. Figure 13 shows the USB-1208FS transfer function with gain error. Gain error is easily converted to voltage by multiplying the full-scale (**FS**) input by the error.

The accuracy plots in Figure 13 are drawn for clarity and are not drawn to scale.

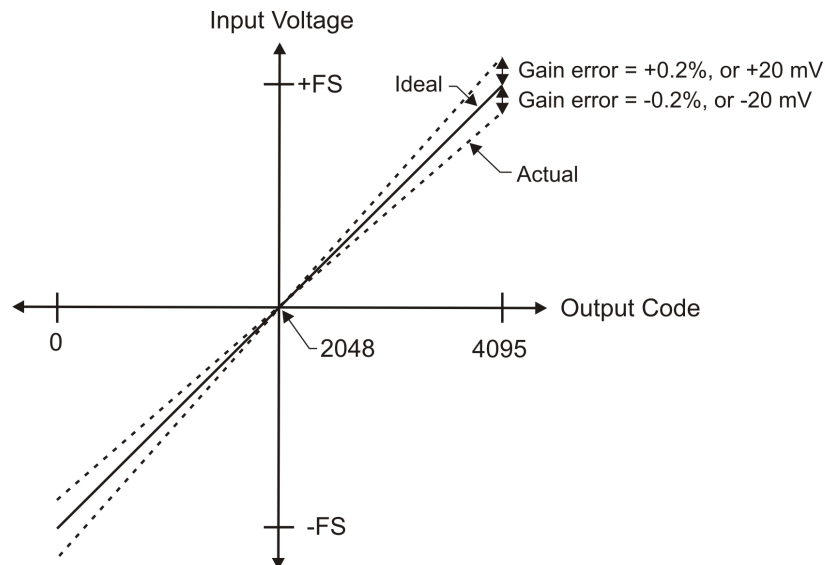

Figure 13. ADC Transfer function with gain error

For example, the USB-1208FS exhibits a typical calibrated gain error of $\pm 0.2\%$ on all ranges. For the $\pm 10\text{ V}$ range, this would yield $10\text{ V} \times \pm 0.002 = \pm 20\text{ mV}$. This means that at full scale, neglecting the effect of offset for the moment, the measurement would be within 20 mV of the actual value. Note that gain error is expressed as a ratio. Values near $\pm\text{FS}$ are more affected from an absolute voltage standpoint than are values near mid-scale, which see little or no voltage error.

Combining these two error sources in Figure 14, we have a plot of the error band of the USB-1208FS for the $\pm 10\text{ V}$ range. This is a graphical version of the typical accuracy specification of the product.

The accuracy plots in Figure 14 are drawn for clarity and are not drawn to scale.

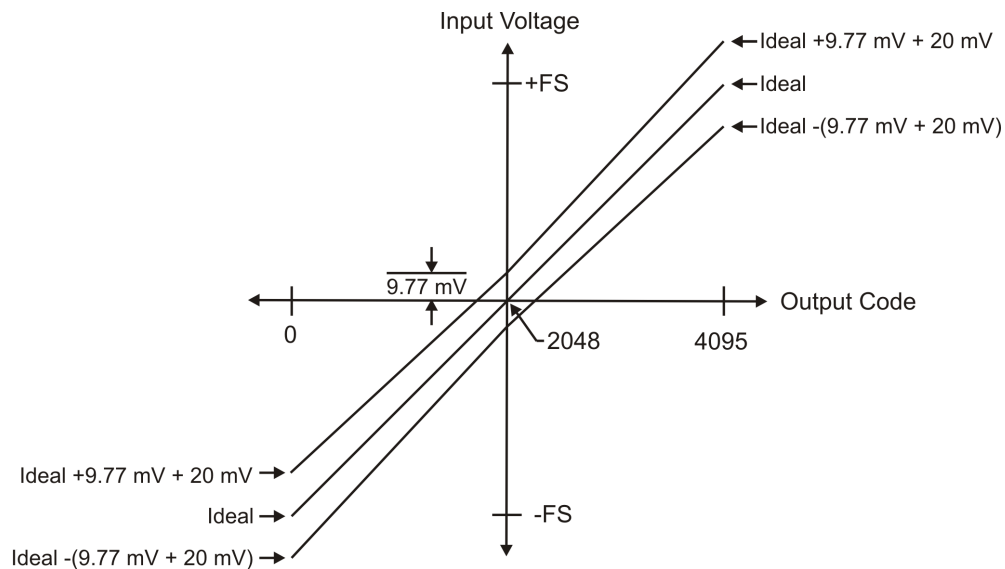

Figure 14. Error band plot

Synchronized operations

You can run up to two USB-1208FS devices on most computers. You can connect the SYNC pin of two devices together in a master/slave configuration and acquire data from the analog inputs of both devices using one clock. When the SYNC pin is configured as an output, the internal A/D pacer clock signal is sent to the screw terminal. You can output the clock to the SYNC pin of a second device that is configured for A/D pacer input.

Mechanical drawings

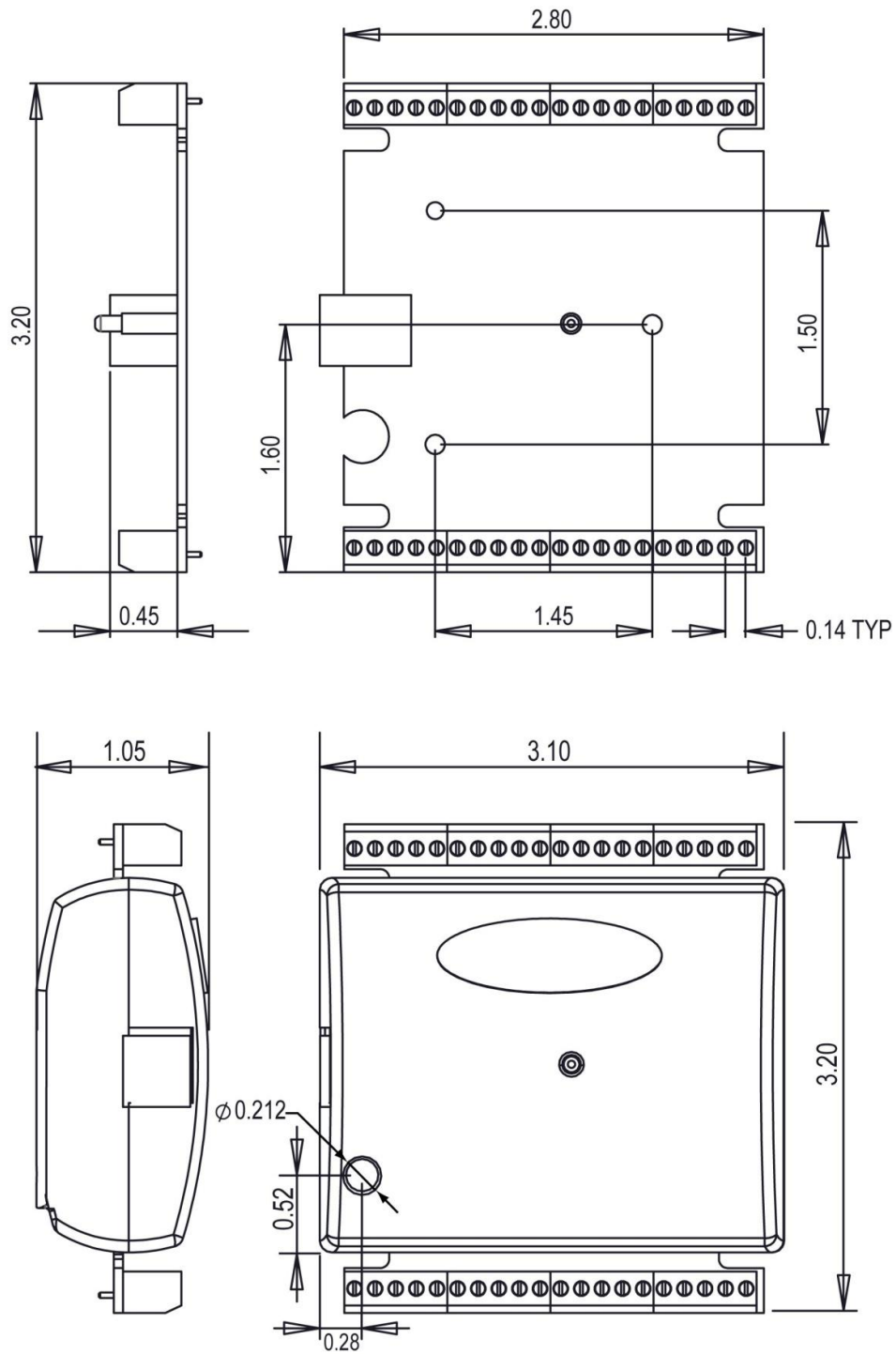

Figure 15. Circuit board (top) and enclosure dimensions

Specifications

All specifications are subject to change without notice.

Typical for 25°C unless otherwise specified.

Specifications in *italic text* are guaranteed by design.

Analog input

Table 1. Analog input specifications

Parameter	Conditions	Specification
A/D converter type		Successive approximation type
Input voltage range for linear operation, single-ended mode	CHx to GND	±10 volts (V) max
Input common-mode voltage range for linear operation, differential mode	CHx to GND	−10 V min, +20 V max
<i>Absolute maximum input voltage</i>	<i>CHx to GND</i>	<i>±28 V max</i>
<i>Input impedance</i>		<i>122 kΩ</i>
Input current (Note 1)	V _{in} = +10 V	70 μA typ
	V _{in} = 0 V	−12 μA typ
	V _{in} = −10 V	−94 μA typ
Number of channels	Software-selectable	8 single-ended / 4 differential
Input ranges, single-ended mode		±10 V, G=2
Input ranges, differential mode	Software-selectable	±20 V, G=1 ±10 V, G=2 ±5 V, G=4 ±4 V, G=5 ±2.5 V, G=8 ±2.0 V, G=10 ±1.25 V, G=16 ±1.0 V, G=20
Throughput (Note 2)	Software paced	250 S/s typ, PC-dependent
	Continuous scan	50 kS/s
Channel gain queue	Up to 16 elements	Software configurable channel, range, and gain.
Resolution (Note 3)	Differential	12 bits, no missing codes
	Single-ended	11 bits
CAL accuracy	CAL = 2.5 V	±36.25 mV max
Integral linearity error		±1 LSB typ
Differential linearity error		±0.5 LSB typ
Repeatability		±1 LSB typ
CAL current	Source	5 mA max
	Sink	20 μA min, 100 μA typ
Trigger source	Software-selectable	External digital: TRIG_IN
Pacer source	Software-selectable	<ul style="list-style-type: none"> ▪ Internal ▪ External (SYNC), rising edge triggered ▪ Programmed IO

Note 1: Input current is a function of applied voltage on the analog input channels. For a given input voltage, V_{in}, the input leakage is approximately equal to (8.181*V_{in} − 12) μA.

Note 2: Maximum throughput scanning to PC memory is machine dependent.

Note 3: The AD7870 converter only returns 11-bits (0 to 2047 codes) in single-ended mode.

Table 2. Accuracy, differential mode

Range	Accuracy (LSB)
±20 V	5.1
±10 V	6.1
±5 V	8.1
±4 V	9.1
±2.5 V	12.1
±2 V	14.1
±1.25 V	20.1
±1 V	24.1

Table 3. Accuracy, single-ended mode

Range	Accuracy (LSB)
±10 V	4.0

Table 4. Accuracy components, differential mode - All values are (±)

Range	% of Reading	Gain Error at full scale (FS) (millivolts (mV))	Offset (mV)	Accuracy at FS (mV)
±20 V	0.2	40	9.766	49.766
±10 V	0.2	20	9.766	29.766
±5 V	0.2	10	9.766	19.766
±4 V	0.2	8	9.766	17.766
±2.5 V	0.2	5	9.766	14.766
±2 V	0.2	4	9.766	13.766
±1.25 V	0.2	2.5	9.766	12.266
±1 V	0.2	2	9.766	11.766

Table 5. Accuracy components, single-ended mode - All values are (±)

Range	% of Reading	Gain Error at FS (mV)	Offset (mV)	Accuracy at FS (mV)
±10 V	0.2	20	19.531	39.531

Table 6. Noise performance, differential mode

Range	Typical counts	Least significant bit _{root mean square} (LSB _{rms})
±20 V	2	0.30
±10 V	2	0.30
±5 V	3	0.45
±4 V	3	0.45
±2.5 V	4	0.61
±2 V	5	0.76
±1.25 V	7	1.06
±1 V	8	1.21

Table 7. Noise performance, single-ended mode

Range	Typical Counts	LSB _{rms}
±10 V	2	0.30

Analog output

Table 8. Analog output specifications

Parameter	Conditions	Specification
Resolution		12-bits, 1 in 4096
Output range		0 V to 4.096 V, 1 mV per LSB
Number of channels		2
Throughput (Note 4)	Software paced	250 S/s single channel typical, PC dependent
	Single channel, continuous scan	10 kS/s
	Dual channel, continuous scan, simultaneous update	5 kS/s
Power on and reset voltage		Initializes to 000h code
Output drive	Each D/A OUT	15 mA
Slew rate		0.8V/microsecond (μ s) typ

Note 4: Maximum throughput scanning to PC memory is machine dependent.

Table 9. Analog output accuracy, all values are (\pm)

Range	Accuracy (LSB)
0 V to 4.096 V	4.0 typ, 45.0 max

Table 10. Analog output accuracy components, all values are (\pm)

Range	% of FSR	Gain Error at FS (mV)	Offset (mV) (Note 5)	Accuracy at FS (mV)
0 V to 4.096 V	0.1 typ, 0.9 max	4.0 typ, 36.0 max	1.0 typ, 9.0 max	4.0 typ, 45.0 max

Note 5: Negative offsets will result in a fixed zero-scale error or "dead band." At the maximum offset of -9 mV, any input code of less than 0x009 will not produce a response in the output.

Digital I/O

Table 11. Digital I/O specifications

Parameter	Specification
Digital type	CMOS
Number of I/O	16 (Port A0 through A7, Port B0 through B7)
Configuration	2 banks of 8
Pull up/pull-down configuration	All pins pulled up to 5V via 47 k Ω resistors (default). Hardware revisions D and later may be changed to pull-down using an internal user-configurable jumper. Previous revisions can be configured at the factory for pull-down.
Input high voltage threshold	2.0 V min
Input high voltage limit	5.5 V absolute max
Input low voltage threshold	0.8 V max
Input low voltage limit	-0.5 V absolute min 0 V recommended min
Output high voltage (IOH = -6.0 mA)	3.84 V min
Output low voltage (IOL = 6.0 mA)	0.33 V max
Power on and reset state	Input

External trigger

Table 12. External digital trigger specifications

Parameter	Conditions	Specification
Trigger source	External, digital	TRIG_IN
Trigger mode	Software-selectable	Edge sensitive: user configurable for CMOS compatible rising or falling edge
Trigger latency		10 μ s max
Trigger pulse width		1 μ s min
Input type		Schmitt trigger, 47 k Ω pull-down to ground
Schmitt trigger hysteresis		1.01 V typ 0.6 V min 1.5 V max
Input high voltage threshold		2.43 V typ 1.9 V min 3.1V max
Input high voltage limit		5.5 V absolute max
Input low voltage threshold		1.42 V typ 1.0 V min 2.0 V max
Input low voltage limit		-0.5 V absolute min 0 V recommended min

External clock input/output

Table 13. External clock I/O specifications

Parameter	Conditions	Specification
Pin name		SYNC
Pin type		Bidirectional
Direction (software-selectable)	Output	Outputs internal A/D pacer clock. Active on rising edge.
	Input (default)	Receives A/D pacer clock from external source. Active on rising edge.
Input clock rate		50 kHz, maximum
Clock pulse width	Input mode	1 μ s min
	Output mode	5 μ s min
Input type		Schmitt trigger, 47 k Ω pull-down to ground
Schmitt trigger hysteresis		1.01 V typ 0.6 V min 1.5 V max
Input high voltage threshold		2.43 V typ 1.9 V min 3.1V max
Input high voltage limit		5.5 V absolute max
Input low voltage threshold		1.42 V typ 1.0 V min 2.0 V max
Input low voltage limit		-0.5 V absolute min 0 V recommended min
Output high voltage		4.4 V min (IOH = -50 μ A) 3.80 V min (IOH = -8 mA)
Output low voltage		0.1 V max (IOL = 50 μ A) 0.44 V max (IOL = 8 mA)

Counter

Table 14. Counter specifications

Parameter	Specification
Pin name	CTR
Counter type	Event counter
Number of channels	1
Input type	Schmitt trigger, 47 k Ω pull-down to ground, rising edge triggered
Input source	CTR screw terminal
Resolution	32 bits
Maximum input frequency	1 MHz
High pulse width	500 ns min
Low pulse width	500 ns min
Schmitt trigger hysteresis	1.01 V typ 0.6 V min 1.5 V max
Input high voltage threshold	2.43 V typ 1.9 V min 3.1V max
Input high voltage limit	5.5 V absolute max
Input low voltage threshold	1.42 V typ 1.0 V min 2.0 V max
Input low voltage limit	-0.5 V absolute min 0 V recommended min

Non-volatile memory

Table 15. Non-volatile memory specifications

EEPROM	1,024 bytes		
EEPROM Configuration	Address Range	Access	Description
	0x000 to 0x07F	Reserved	128 bytes system data
	0x080 to 0x1FF	Read/write	384 bytes cal data
	0x200 to 0x3FF	Read/write	512 bytes user area

Microcontroller

Table 16. Microcontroller specifications

Parameter	Specification
Type	High performance 16-bit RISC microcontroller

Power

Table 17. Power specifications

Parameter	Conditions	Specification
Supply current (Note 6)		80 mA
+5V USB power available (Note 7)	Connected to self-powered hub	4.5 V min, 5.25 V max
	Connected to externally-powered root port hub	
	Connected to bus-powered hub	4.1 V min, 5.25 V max
Output current (Note 8)	Connected to self-powered hub	420 mA max
	Connected to externally-powered root port hub	20 mA max
	Connected to bus-powered hub	

Note 6: This is the total current requirement for the USB-1208FS which includes up to 10 mA for the status LED.

Note 7: *Self-powered hub* refers to a USB hub with an external power supply. Self-powered hubs allow a connected USB device to draw up to 500 mA.

Root port hubs reside in the PC's USB host controller. The USB port(s) on your PC are root port hubs. All externally powered root port hubs (desktop PCs) provide up to 500 mA of current for a USB device. Battery-powered root port hubs provide 100 mA or 500 mA, depending upon the manufacturer. A laptop PC that is not connected to an external power adapter is an example of a battery-powered root port hub.

Bus powered hubs receive power from a self-powered or root port hub. In this case the maximum current available from the USB +5 V is 100 mA. The minimum USB +5 V voltage level can be as low as 4.1 V.

Note 8: This refers to the total amount of current that can be sourced from the USB +5 V, analog outputs and digital outputs.

General

Table 18. General specifications

Parameter	Specification
Device type	USB 2.0 full speed
Device compatibility	USB 1.1, USB 2.0

Environmental

Table 19. Environmental specifications

Parameter	Specification
Operating temperature range	0 °C to 70 °C
Storage temperature range	-40 °C to 70 °C
Humidity	0% to 90% non-condensing

Mechanical

Table 20. Mechanical specifications

Parameter	Specification
Dimensions	79 × 82 × 27 mm (3.10 × 3.20 × 1.05 in.)
USB cable length	3 m (9.84 ft) max
User connection length	3 m (9.84 ft) max

Screw terminal connector

Table 21. Screw terminal specifications

Parameter	Specification
Connector type	Screw terminal
Wire gauge range	16 AWG to 30 AWG

Differential mode pinout

Table 22. 4-channel differential mode pinout

Pin	Signal Name	Pin	Signal Name
1	CH0 IN HI	21	Port A0
2	CH0 IN LO	22	Port A1
3	AGND	23	Port A2
4	CH1 IN HI	24	Port A3
5	CH1 IN LO	25	Port A4
6	AGND	26	Port A5
7	CH2 IN HI	27	Port A6
8	CH2 IN LO	28	Port A7
9	AGND	29	GND
10	CH3 IN HI	30	PC +5V
11	CH3 IN LO	31	GND
12	AGND	32	Port B0
13	D/A OUT 0	33	Port B1
14	D/A OUT 1	34	Port B2
15	AGND	35	Port B3
16	CAL	36	Port B4
17	GND	37	Port B5
18	TRIG_IN	38	Port B6
19	SYNC	39	Port B7
20	CTR	40	GND

Single-ended mode pinout

Table 23. 8-channel single-ended mode pinout

Pin	Signal Name	Pin	Signal Name
1	CH0 IN	21	Port A0
2	CH1 IN	22	Port A1
3	AGND	23	Port A2
4	CH4 IN	24	Port A3
5	CH3 IN	25	Port A4
6	AGND	26	Port A5
7	CH6 IN	27	Port A6
8	CH5 IN	28	Port A7
9	AGND	29	GND
10	CH6 IN	30	PC +5V
11	CH7 IN	31	GND
12	AGND	32	Port B0
13	D/A OUT 0	33	Port B1
14	D/A OUT 1	34	Port B2
15	AGND	35	Port B3
16	CAL	36	Port B4
17	GND	37	Port B5
18	TRIG_IN	38	Port B6
19	SYNC	39	Port B7
20	CTR	40	GND

CE Declaration of Conformity

Manufacturer: Measurement Computing Corporation
Address: 10 Commerce Way
Suite 1008
Norton, MA 02766
USA
Category: Electrical equipment for measurement, control and laboratory use.

Measurement Computing Corporation declares under sole responsibility that the product

USB-1208FS

to which this declaration relates is in conformity with the relevant provisions of the following standards or other documents:

EU EMC Directive 89/336/EEC: Electromagnetic Compatibility, EN 61326 (1997) Amendment 1 (1998)

Emissions: Group 1, Class A

- EN 55011 (1990)/CISPR 11: Radiated and Conducted emissions.

Immunity: EN61326, Annex A

- IEC 1000-4-2 (1995): Electrostatic Discharge immunity, Criteria C.
- IEC 1000-4-3 (1995): Radiated Electromagnetic Field immunity Criteria A.
- IEC 1000-4-4 (1995): Electric Fast Transient Burst immunity Criteria C.
- IEC 1000-4-5 (1995): Surge immunity Criteria A.
- IEC 1000-4-6 (1996): Radio Frequency Common Mode immunity Criteria A.
- IEC 1000-4-8 (1994): Magnetic Field immunity Criteria A.
- IEC 1000-4-11 (1994): Voltage Dip and Interrupt immunity Criteria A.

Declaration of Conformity based on tests conducted by Chomerics Test Services, Woburn, MA 01801, USA in August, 2004. Test records are outlined in Chomerics Test Report #EMI3948.04.

We hereby declare that the equipment specified conforms to the above Directives and Standards.



Carl Haapaoja, Director of Quality Assurance

Measurement Computing Corporation
10 Commerce Way
Suite 1008
Norton, Massachusetts 02766
(508) 946-5100
Fax: (508) 946-9500
E-mail: info@mccdaq.com
www.mccdaq.com